



Venue Fit™

Made for Your Point of Care.

Simple. Fast. Precise.



Meet **Venue Fit**,
the newest member
of the Venue™ Family
of point of care
ultrasound systems.

Designed for Your Needs, Adapts for Your Challenges.

A simple, fast and precise way to assess a patient's medical status at the point of care, meet Venue Fit, the newest member of the Venue Family of point of care ultrasound systems. Designed to fit your practice, fit your space and fit your needs, Venue Fit is streamlined yet powerful. A small but efficient point of care ultrasound system with features you have come to know and love from the Venue Family.

Made for you.

Venue Fit's design enables a fast and confident diagnosis. Built on Windows® 10 with a powerful imaging engine utilizing cSound™ technology, a small footprint and slim design, it's adaptable for your department. The Venue Fit is ready when and where you are.



Touch, pinch, swipe

No buttons. No knobs. A familiar 14-inch touch screen with a simple, clear and intuitive interface works even with gloves or screen covers.



Probes up top

Easily access probes and keep them in good condition with smart cable management that puts probes safely up top and cables out of the way. Probes are kept high in the holder to enable application of a sterile cover.



Infection control

Easy to clean, smooth and seamless surface supports infection control efforts.



Uniquely adaptable

Detachable holders and bins allow you to configure the system cart to fit your needs. Store gel packets and needles in easy reach and connect the larger bin to the front or back- if you need to get closer bedside.



Raise and lower with ease

Use the foot pedal to easily raise or lower the system for an optimal view and comfortable ergonomics - even while seated.



Moves with you

A small footprint with large casters easily maneuver the system to the bedside, navigate between equipment and reach tight spaces common in point of care.



Ready to scan

Equipped with two active probe ports and a long-lasting battery providing up to 1 hour of scan time. An easy to see count-down timer changes color when you are running low.



Cart, kickstand or VESA® connection options.



Shared platform

One common platform gives users the same experience regardless of system being used and enables facilities to simplify their training protocols.



Work smarter, not harder

Precise tools are designed to enable fast patient assessments and confident decisions. Utilizing proprietary algorithms, we synthesized patient data to ensure accurate calculations for clinical confidence.



Built for durability

A screen durable enough to withstand bumps, bangs and splashes, will not hit the wall thanks to the bumpers and multipurpose handle on the system.



Made for Your Point of Care.

Inspired by the needs of physicians, Venue Fit, was developed specifically for point of care medicine. No two patients are the same, nor are the needs of physicians whose practices range from Anesthesia to MSK. Built for a wide range of environments, its smaller footprint and increased portability makes Venue Fit a flexible solution for your point of care needs.

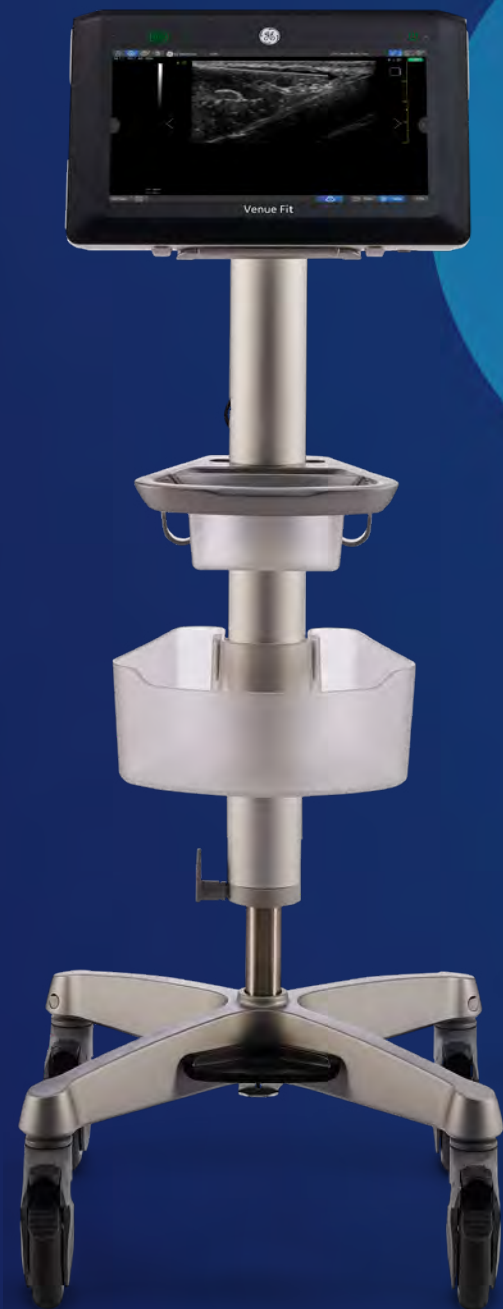

Simple. Fast. Precise.

Smart Enough to Keep You Moving.

Designed to handle the busywork so you can focus on your patients, Venue Fit helps you find the information you need now. Helping you to work smarter, not harder, our protocol management and easy documentation features provide a visual overview of the entire exam while reducing the need to manually type findings.

Simplify your workflow.

 **Reduce keystrokes**
by up to **80%**¹



eFAST Diagram

Assess and document patient status, from internal bleeding to pneumothorax, aligned to the eFAST protocol.

 **Tap and Select Findings**

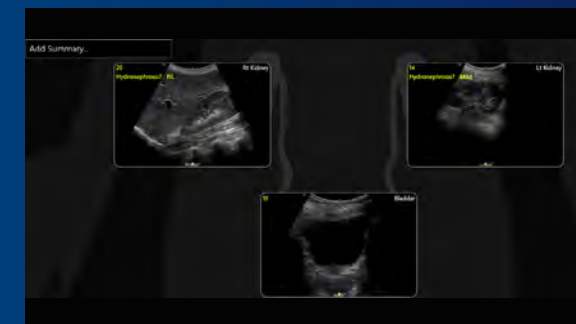

Renal Diagram

Simplify documentation and provide easy follow up for patients with suspected hydronephrosis.

No need to manually type findings, simply tap the appropriate label that corresponds to your image.

 **LUSS in one view**

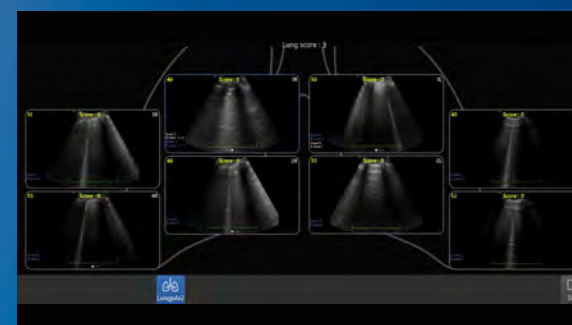

Lung Diagram

A single view diagram of anatomical lung segments with one click image storing. Keeps track of your segmental lung assessment and can be helpful in showing trends in response to therapy.





Excellent image quality with probes built for needle procedures

Experience clear images on a range of patients, from adult to pediatric, with a variety of linear, curved and cardiac probes available to support procedural needs. Probes used with Venue Fit are also compatible with Venue and Venue Go™.⁴

L4-20t-RS XDclear™, ultra-wide band probe supports high-frequency imaging of superficial structures while also being able to penetrate deeper anatomy without compromising imaging quality.² This lightweight probe features a longer cable so you can easily reach across the bed or patient when performing needle procedures.

With our button probes, you can perform procedures while controlling multiple parameters of the system from the probe without breaking the sterile field. Needle procedures that once required two people can now be done with one.

XDclear Technology

Single Crystal: Advanced piezoelectric material that delivers high quality acoustic signal

Acoustic Amplifier: captures and redirects the unused energy that passes through the crystal

Cool Stack: Patented technology that relieves inherent heat generation

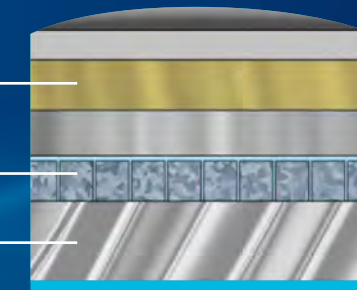

Made for Anesthesia.

From block to periop, the Venue Family has you covered. Whether you are performing needle guided procedures or perioperative care, we support the spectrum of use with vibrant images, and a suite of proven tools that simplify complicated assessments.

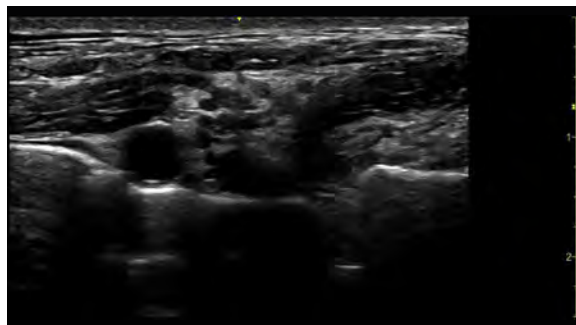

Precise blocks

Needle visualization at deep and shallow depths on even the most challenging body types.



18% larger image size

Remove the clutter | Simple Screen

See an 18% larger ultrasound image and view only the icons you want by activating Simple Screen mode.⁵

Made for MSK.

The Venue Fit was made for MSK practitioners who need to assess tendons, muscles and joints, and manage patient progress during a course of treatment. Improve patient and practitioner experience by: offering needle technology to assist in guiding injections to the correct location, follow-up functions for progress assessment over time and a full array of high-frequency imaging probes for clear assessment of deep and shallow anatomy.

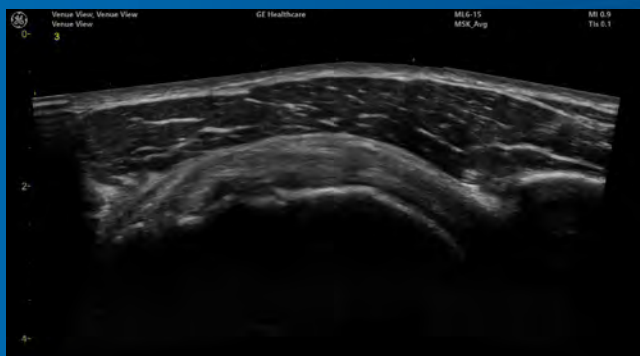

With our button probes, you can perform procedures while controlling multiple parameters of the system from the probe without breaking the sterile field. Needle procedures that once required two people can now be done with one.

Quickly and accurately assess patient progress | Follow Up

Deliver consistent and clear conclusions for repeated exams on the same patient, Follow Up automatically recalls parameter settings from a previous exam including comments and body patterns.

Supports monitoring of patient response to treatment over time by allowing a side by side view of historical and new images.

A|B Automatically recalls parameter settings

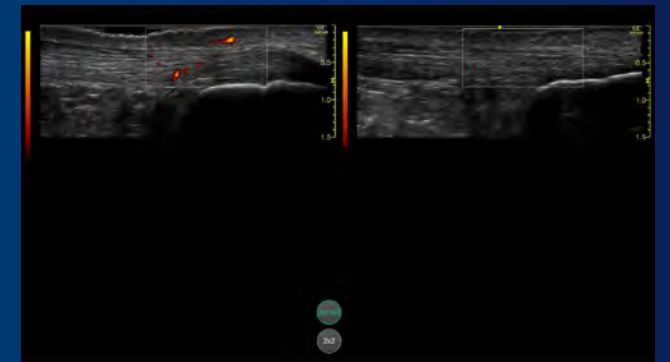

View up to 60cm of anatomy being scanned

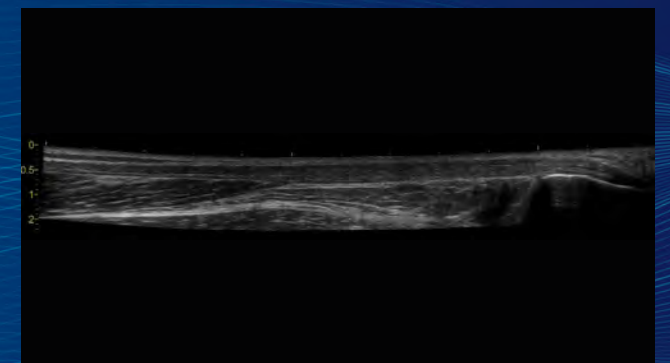

See the anatomy you need in one view | Venue View

Support diagnostic confidence by constructing a panoramic image from individual frames. With Venue View, clinicians can view up to 60cm of anatomy being scanned with anatomical relationships in one view.

Venue View works with all linear probes available with the Venue Fit.

Only what you need to see



Remove the clutter | Simple Screen

See an 18% larger ultrasound image and view only the icons you want by activating Simple Screen mode.⁵

Excellent image quality with probes built for needle procedures

Experience clear images on a range of patients, from adult to pediatric, with a variety of linear, curved and cardiac probes available to support procedural needs. Probes used with Venue Fit are also compatible with Venue and Venue Go.⁴

L4-20t-RS XDclear™, ultra-wide band probe supports high-frequency imaging of superficial structures while also being able to penetrate deeper anatomy without compromising imaging quality.² This lightweight probe features a longer cable so you can easily reach across the bed or patient when performing needle procedures.

Made for Pediatric and Neonatal Patients.

Venue Fit is designed to address the specific needs of pediatric and neonatal patients. Enabling fast and confident diagnostic scans without ionizing radiation for your complete evaluation of your littlest patients.



LUSS in one view | Lung Diagram

Lung diagram visually maps out lung segments and automatically calculates the Lung Ultrasound Score (LUSS) based on user input.

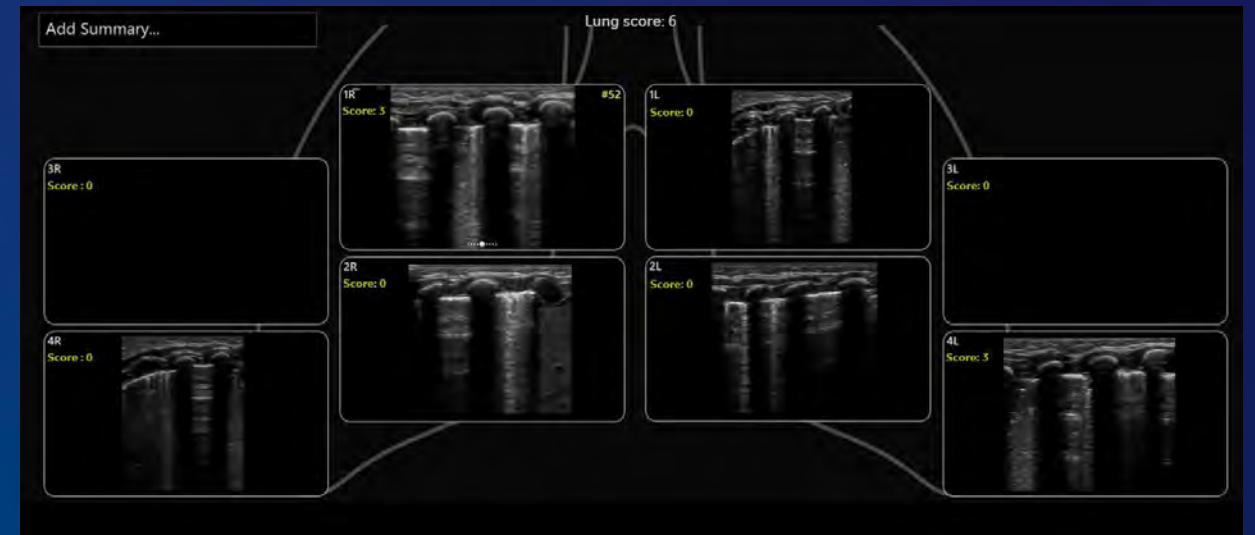

Pediatric probes | Accessories

With Pediatric ECG and a full set of probes for scanning pediatric patients ranging from neonates up to adult sized patients, the Venue Fit has you covered.



L10-22 -RS

12S -RS

8C -RS

L4-20t -RS

6S -RS

Pneumonia is the single largest infectious cause of death in children worldwide.³



Made for Reliability.

Training solutions

Our portfolio of training for clinical and technical users, helps build customized development plans to foster excellence and increased confidence.

Proactive monitoring

Use digital technology and tools to minimize expensive and disruptive unplanned downtime. Reduce cost and revenue loss from unplanned failures and receive updates for peace of mind.

Device protection

Keep your device up to date with software updates, new applications and security patches. Optimize your device to drive clinical and operational benefits and help you stay ahead of the game, without changing your equipment.

Asset optimization

Customizable dashboards for asset utilization. Achieve more with your assets to improve patient care and realize department strategic plans.

Improved uptime

Excellent repair services to drive uptime. Fully scalable from full coverage to shared maintenance. Thoroughly aligned with your own in-house capabilities, providing the right balance between staff autonomy and our expertise.

Probe performance

Customizable portfolio of solutions for probe lifecycle needs to improve availability and performance. Proactive probe care to help you increase diagnostic quality, decrease cross-contamination risk and expand the life span of the transducers.



Made for Security.

SonoDefense is GE Healthcare's multi-layer strategic approach to cybersecurity and patient data privacy for ultrasound, and designed to:

- Keep the ultrasound machine safe and functional in the face of cyberthreats
- Protect patient data on the machine from unauthorized access
- Enable you to successfully implement HIPAA and security policies, while still managing productive daily workflows

Defense-in-depth strategy

SonoDefense is designed for maximum security protection with a defense-in-depth strategy that incorporates security controls deployed in multiple layers. This approach enhances security by protecting the system against any particular attack using several independent methods.

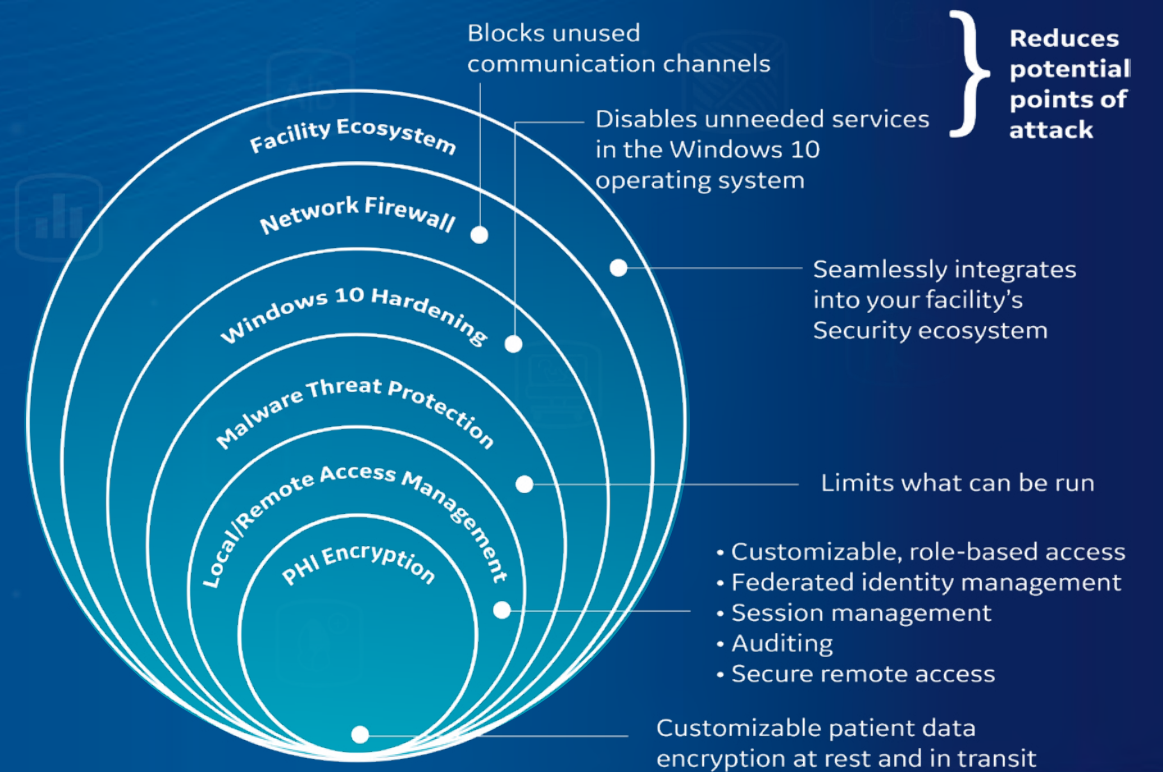

Award-winning

The Venue Family's innovative design was made to stand out.



IF International |
2020 Winner



Good Design International |
Australia - 2019 Gold



Good Design USA |
2019 Winner



IDSA IDEA |
2019 Silver



UX Design Award |
2019 Winner



 venue-pocus.gehealthcare.com

*** Products mentioned in the material may be subject to government regulation and may not be available in all countries. Shipment and the effective sale can only occur after approval from the regulator. Some applications or probes may not be available on all product versions.**

- 1 Requiring up to 80% fewer keystrokes, this tool helps clinicians quickly assess and document patient status – from internal bleeding to a pneumothorax – by mapping key areas of the body in a way that is intuitive and aligned with clinical workflows. eFAST Comparison Study: Manual vs. Venue Automation, GE Internal Study DOC2222911.
- 2 XDClear transducers are GE Healthcare's highest performing transducers featuring new advances in acoustic engineering.
- 3 <https://www.who.int/en/news-room/fact-sheets/detail/pneumonia>
- 4 L12n-RS is only available on Venue.
- 5 Supporting evidence for Venue Fit is documented in DOC2454794



© 2021 General Electric Company. GE, the GE monogram, Venue, Venue Go, Venue Fit, cSound and XDClear are trademarks of General Electric Company. VESA is a registered trademark of the Video Electronics Standards Association. Windows is a registered trademark of Microsoft Corporation.

Product may not be available in all countries and regions. Full product technical specification is available upon request. Contact a GE Healthcare Representative for more information. Please visit www.gehealthcare.com/promotional-locations. Data subject to change.

January 2021 JB02161XX